

Article number: 5725027207

Description: NSK Cirkular flange unit UCFC207D1

Measures

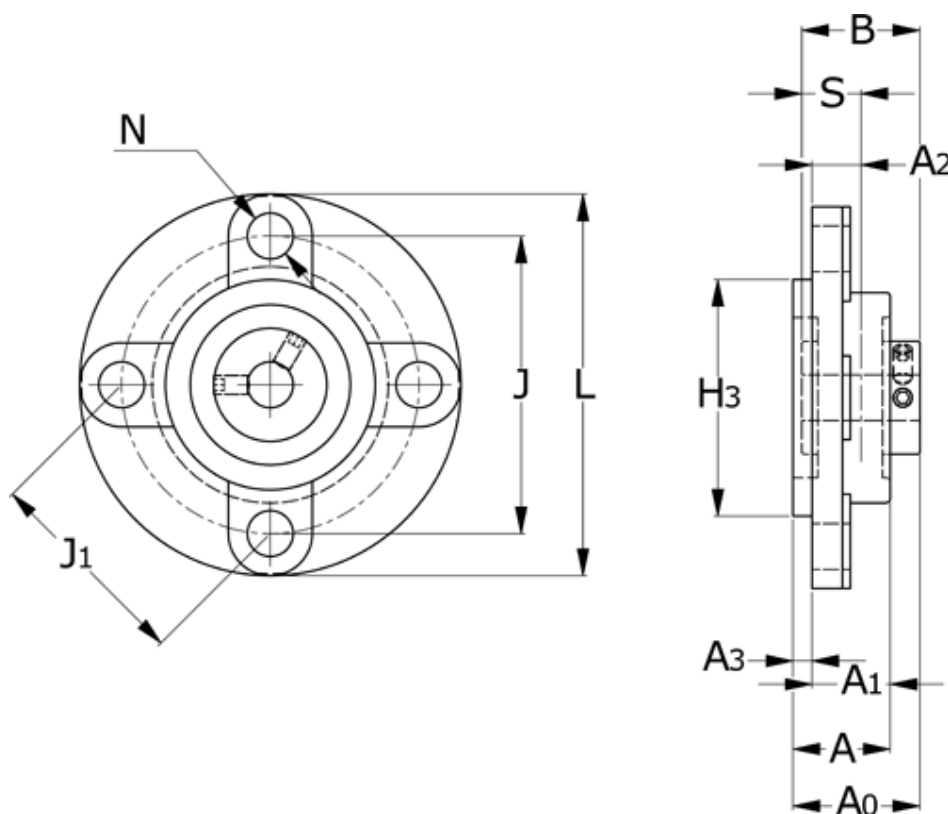

A = 34	J1 = 77.8
A0 = 44.4	L = 135
A1 = 26	N = 14
A2 = 11	S = 17.5
A3 = 8	Shaft = 35
B = 42.9	
H3 = 90	
J = 110	